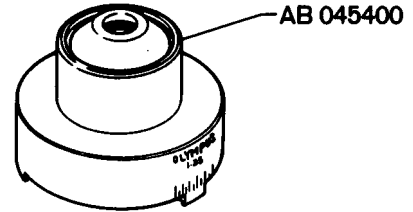
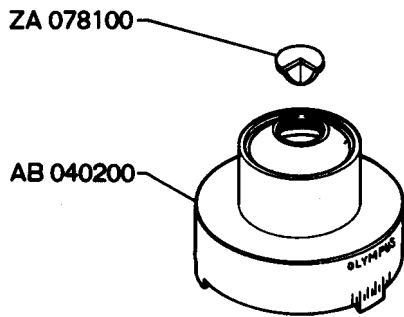
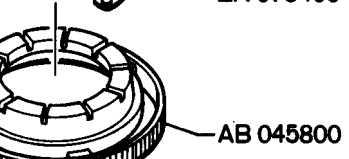
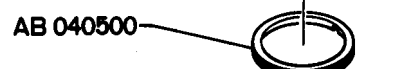
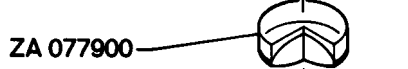
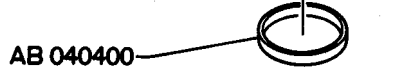
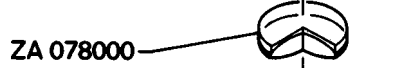
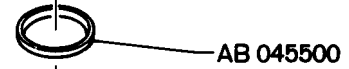
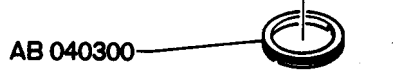
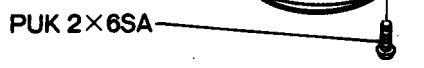

A**B****C****D****B2-AAC****B2-CD****1****2****3****4****EXPLODED PARTS DIAGRAM**

MODEL	UNIT	FIG
BH2	B2-CD B2-AAC	17
OLYMPUS OPTICAL CO., LTD. TOKYO, JAPAN		

NOTE: WHEN ORDERING FOR SPARE PARTS, PLEASE CLARIFY A MODEL OR UNIT, PARTS NUMBER AND QUANTITY.

部 番 PARTS No.	部 品 名 NAME OF PARTS	個数 Q'ty	部 番 PARTS No.	部 品 名 NAME OF PARTS	個数 Q'ty
B2-AAC			B2-CD		
AB 040200	ホントイ CONDENSER FRAME	1	AB 040800	アリ DOVETAIL	1
040300	R RING	1	045400	ホントイ CONDENSER FRAME	1
040400	dp SPACER RING	1	045500	オサエイタ RING	1
040500	R RING	1	045600	R RING	1
040700	シボリリング DIAPHRAGM RING	1	045800	シボリリング DIAPHRAGM RING	1
040800	アリ DOVETAIL	1			
			SA 023800	リング RING	1
LA 457100	レンズ LENS	1			
			LA 457400	レンズ LENS	1
ZA 078700	ハネ DIAPHRAGM BLADE	8	457500	レンズ LENS	1
077900	レンズ LENS	1			
078100	レンズ LENS	1	ZA 079400	ハネ DIAPHRAGM BLADE	10
PUK 2X6SA	ビス SCREW	3	PUK 2X6SA	ビス SCREW	3

A | B | C | D

1

2

3

4

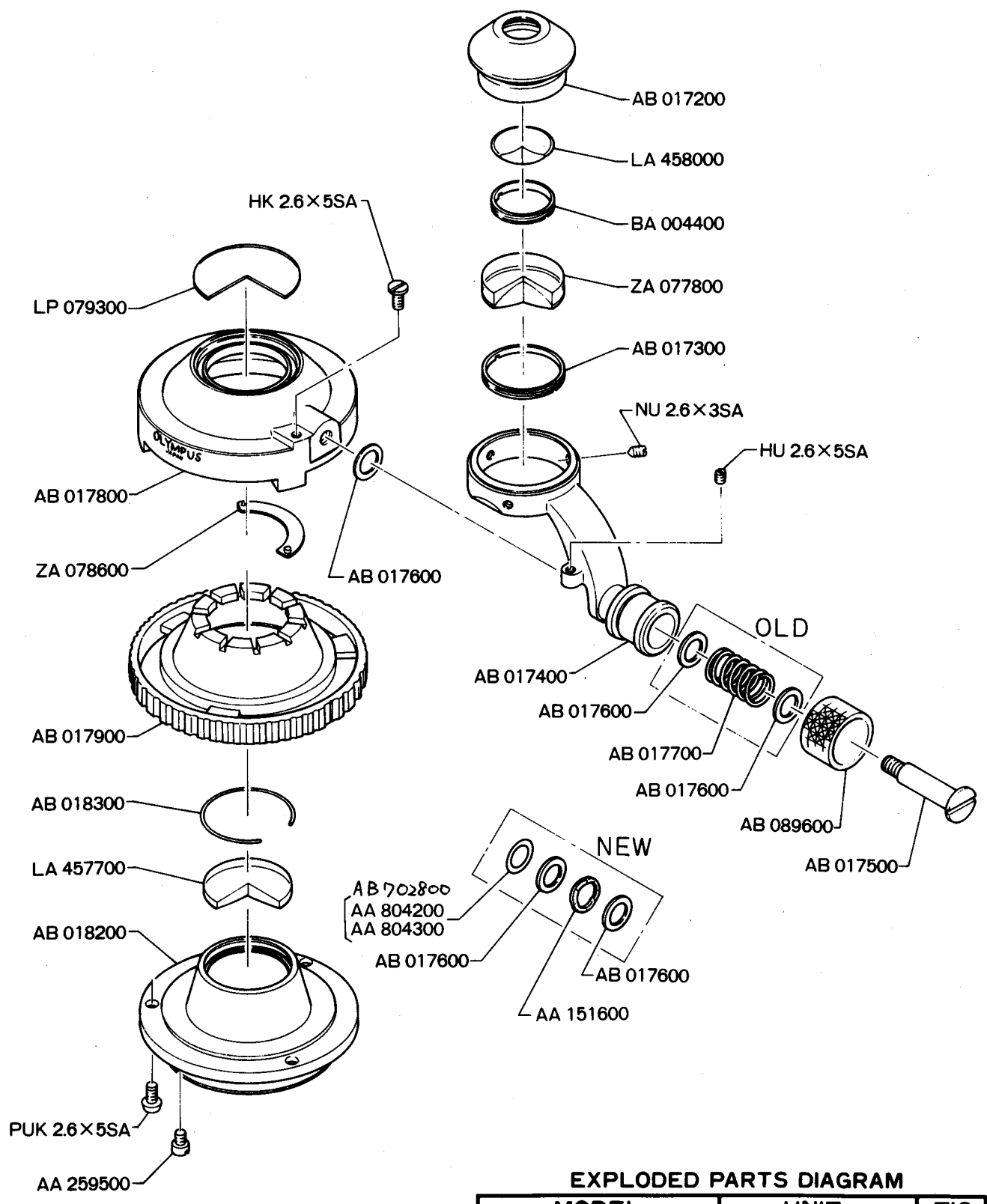

EXPLODED PARTS DIAGRAM

MODEL	UNIT	FIG
BH2	B2-SC	18

OLYMPUS OPTICAL CO., LTD. TOKYO, JAPAN

NOTE: WHEN ORDERING FOR SPARE PARTS, PLEASE CLARIFY A MODEL OR UNIT, PARTS NUMBER AND QUANTITY.

③

1114

PARTS NO.	NAME OF PARTS	Q' ty	PARTS NO.	NAME OF PARTS	Q' ty
259500	HK	1			
259500	HK	1			
017300	R	1			
017400	アーム	1			
AB702800	W	1			
AB017200	L フク	1			
017300	R	1			
017400	アーム	1			
017500	ジク	1			
017600	W	3			
017800	本体	1			
017900	シボリリング	1			
018200	アリ	1			
018300	トメバネ	1			
089600	ゴムカン	1			
BA004400	R	1			
LA457700	レンズ	1			
458000	レンズ	1			
LP079300	ガラス	1			
ZA077800	レンズ	1			
078600	ハネ	10			
PUK2.6x 5 SA	ビス	3			
NU 2.6x 3 SA	ビス	3			
HU 2.6x 5 SA	ビス	1			
HK 2.6x 5 SA	ビス	1			

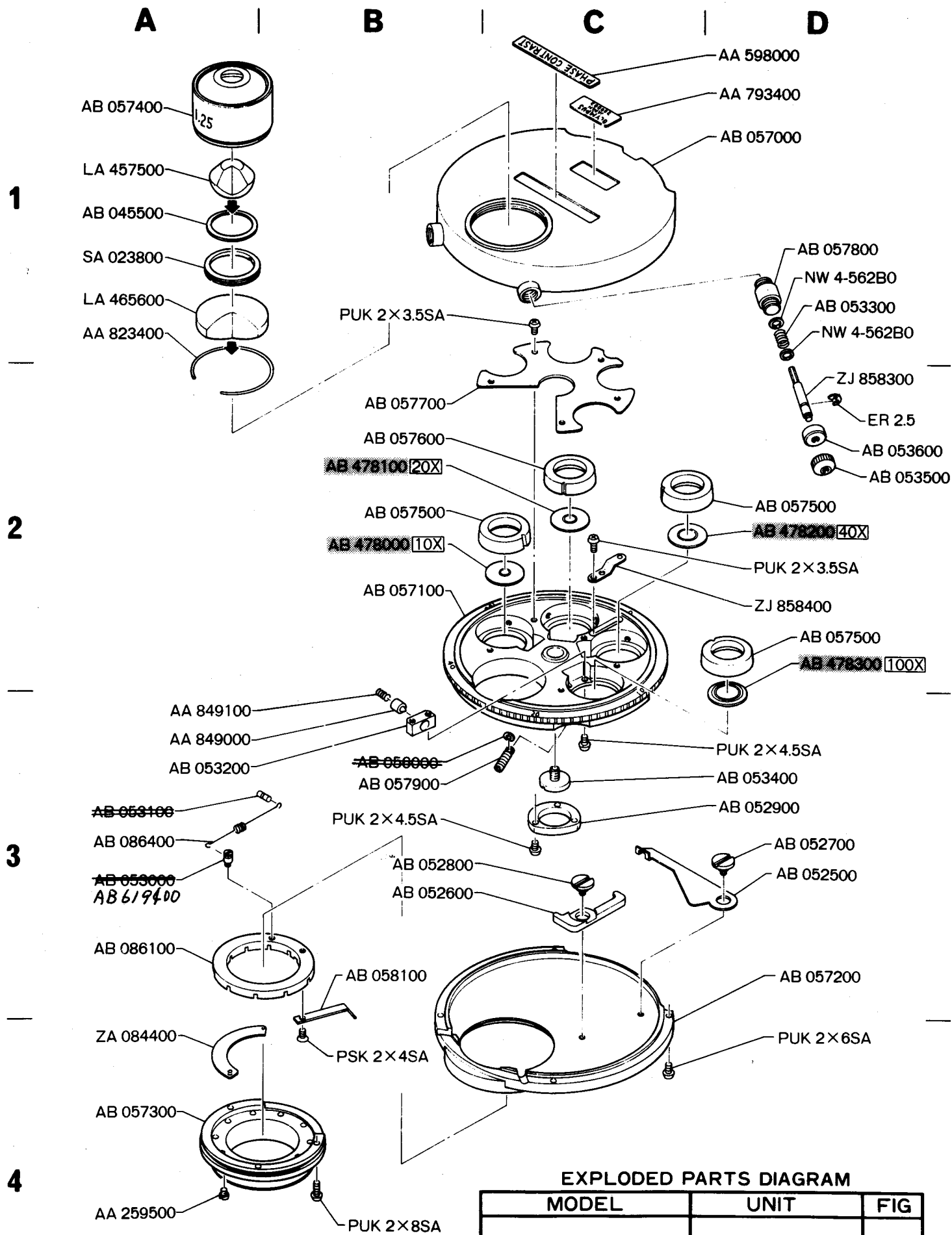

EXPLODED PARTS DIAGRAM

MODEL	UNIT	FIG
BH2	B2-PC	24

OLYMPUS OPTICAL CO., LTD. TOKYO, JAPAN

NOTE: WHEN ORDERING FOR SPARE PARTS, PLEASE CLARIFY A MODEL OR UNIT, PARTS NUMBER AND QUANTITY.

PARTS NO.	NAME OF PARTS	Q' ty	PARTS NO.	NAME OF PARTS	Q' ty	
AA259500	HK	SCREW	1	PUK 2 x3.5SA	ビス SCREW	7
598000	メイバン	NAME PLATE	1	2 x4.5SA	ビス SCREW	11
793400	メイバン	NAME PLATE	1	2 x 6 SA	ビス SCREW	4
823400	リング	RING	1	2 x 8 SA	ビス SCREW	3
849000	バネトウ	SPRING SHAFT	4	PSK 2 x 4 SA	ビス SCREW	1
849100	バネ	SPRING	4	NW 4 -562B0	ワッシャー WASHER	2
AB045500	オサエイタ	RING	1	ER 2.5SA	E リング E-RING	2
052500	レバー	LEVER	1			
052600	レバー	LEVER	1			
052700	DK	SHAFT	1			
052800	DK	SHAFT	1			
052900	カム	CAM	1			
619400 053000	バネウケ	SPRING HOLDER	1			
053200	ダ	MOUNT	4			
053300	バネ	SPRING	2			
053400	HK	SCREW	1			
053500	ツマミ	KNOB	2			
053600	フタ	CAP	2			
057000	PCホンタイ	UPPER FRAME	1			
057100	ターレット	TURRET	1			
057200	PCフタ	LOWER FRAME	1			
057300	アリ	CIRCULAR DOVETAIL	1			
057400	ワケ	LENS TUBE	1			
057500	RSワケ	RS-FRAME	3			
057600	RSワケ20	RS-FRAME	1			
057700	オサエイタ	SETTING PLATE	1			
057800	ツツ	TUBE	2			
057900	ネジ	SCREW	8			
058100	ハンドル	LEVER	1			
086100	マワシカン	ROTATING RING	1			
086400	バネ	SPRING	1			
47800		LIGHT APERTURE	1			
478100		LIGHT APERTURE	1			
478200		LIGHT APERTURE	1			
478300		LIGHT APERTURE	1			
LA465600	レンズ	LENS	1			
465700	レンズ	LENS	1			
SA023800	リング	RING	1			
ZA084400	ハネ	DIAPHRAGM BLADE	10			
ZJ858300	レンチ	SHAFT	2			
858400	クリック	CLICK SPRING	1			

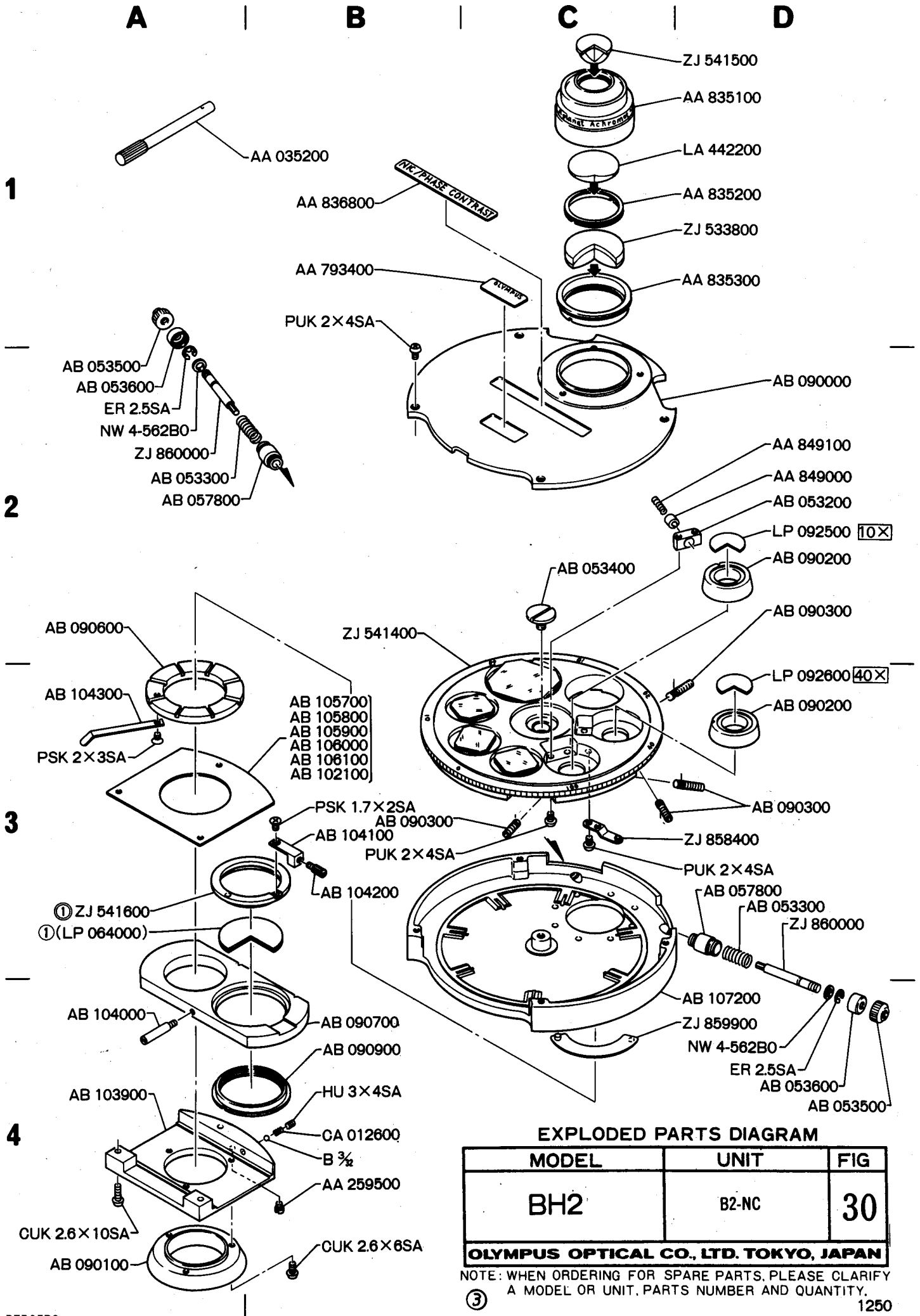

EXPLODED PARTS DIAGRAM

MODEL	UNIT	FIG
BH2	B2-NC	30

OLYMPUS OPTICAL CO., LTD. TOKYO, JAPAN

NOTE: WHEN ORDERING FOR SPARE PARTS, PLEASE CLARIFY A MODEL OR UNIT, PARTS NUMBER AND QUANTITY.

③

1250

PARTS NO.	NAME OF PARTS		Q' ty	PARTS NO.	NAME OF PARTS		Q' ty
AA035200	ハンドル	HANDLE	1	WE114026	CUK2. 6X6SA	SCREW	3
259500	HK	SCREW	1	114002	CUK2. 6X10SA	SCREW	3
793400	メイバン	NAME PLATE	1				
835100	ソトワク	OUTER FRAME	1	WE117130	HU3X4SA	SCREW	1
835200	R	RING	1				
835300	オサエリング	RING	1	WE107078	PSK1. 7X2SA	SCREW	1
836800	メイバン	NAME PLATE	1	107132	PSK2X3SA	SCREW	1
849000	バネトウ	SPRING TUBE	2				
849100	バネ	SPRING	2	WE115290	PUK2X4SA	SCREW	10
AB053200	ザ	MOUNT	2	WE301332	NW4-562B0	WASHER	2
053300	バネ	SPRING	2				
053400	HK	SCREW	1	WE307024	ER2. 5SA	E-RING	2
053500	ツマミ	KNOB	2				
053600	フタ	COVER	2	WE201038	B3/32	BALL	1
057800	ツツ	TUBE	2				
090000	NCフタ	NC-COVER	1				
090100	NCアリ	NC-DOVETAIL	1				
090200	RSワク	RS-FRAME	2				
090300	ネジ	SCREW	4				
090600	マワシカン	ROTATING RING	1				
090700	スライダ	SLIDER	1				
090900	シメカン	FIXING RING	1				
102100	W-3	WASHER 3	0 ~				
105700	W-5	WASHER 5					
105800	W-10	WASHER 10					
105900	W-20	WASHER 20					
106000	W-30	WASHER 30					
106100	W-40	WASHER 40					
104000	ツマミ	KNOB	1				
104100	ザ	MOUNT	1				
104200	ツマミ	KNOB	1				
104300	ハンドル	HANDLE	1				
107200	NCホンタイ	NC-BODY	1				
CA012600	バネ	SPRING	1				
LA442200	レンズ	LENS	1				
LP092500	リングスリット	LIGHT ANNULUS	1				
092600	リングスリット	LIGHT ANNULUS	1				
ZJ533800	レンズ	CE-LENS	1				
541400	NCターレット	NC-TURRET	1				
541500	レンズ	CE-LENS	1				
541600	ポラライザ	POLARIZER	1				
858400	クリックバネ	CLICK SPRING	1				
859900	ハネ	DIAPHRAGM BLADE	8				
860000	ツマミ	KNOB	2				

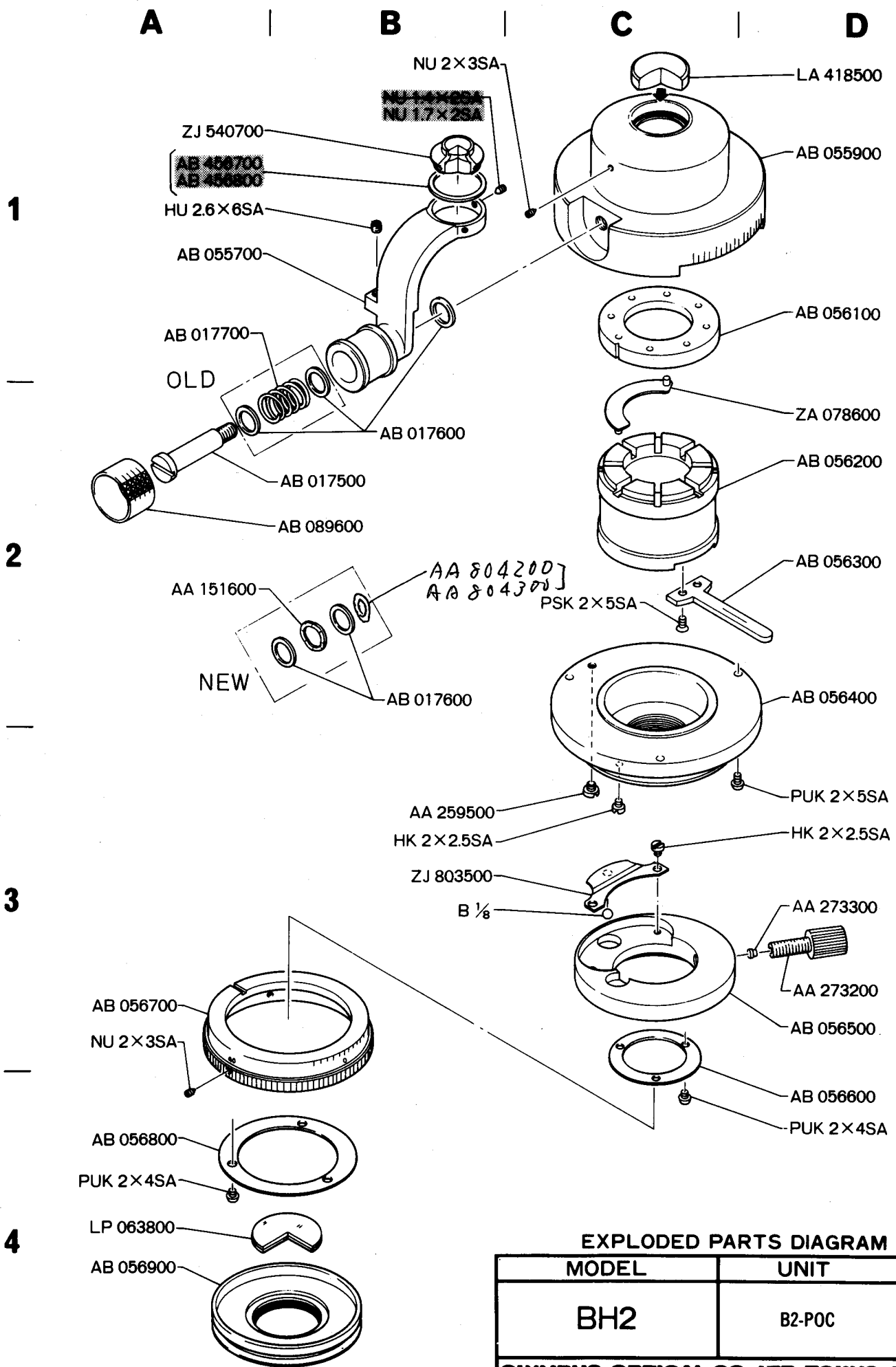

EXPLODED PARTS DIAGRAM

MODEL	UNIT	FIG
BH2	B2-POC	33

OLYMPUS OPTICAL CO., LTD. TOKYO, JAPAN

NOTE: WHEN ORDERING FOR SPARE PARTS, PLEASE CLARIFY A MODEL OR UNIT, PARTS NUMBER AND QUANTITY.

PARTS NO.	NAME OF PARTS	Q' ty	PARTS NO.	NAME OF PARTS	Q' ty		
AA151600	バネザ	WASHER	1	WE101373	HK2X2.5SA	SCREW	3
259500	HK	SCREW	1	WE117087	HU2.6X6SA	SCREW	1
273200	ツマミ	KNOB	1	WE119072	NU1.7X2SA	SCREW	3
273300	ダボ	DOWEL	1	119165	NU2X3SA	SCREW	4
804200	W1	WASHER	0	WE107151	PSK2X5SA	SCREW	2
804300	W3	WASHER	~	WE115290	PUK2X4SA	SCREW	6
AB017500	ジク	SHAFT	1	115301	PUK2X5SA	SCREW	3
017600	W	WASHER	3	WE201039	B1/8	BALL	1
055700	アーム	ARM	1				
055900	ホンタイ	BODY	1				
056100	シボリワク	DIAPHRAGM FRAME	1				
056200	マワシカン	ROTATING RING	1				
056300	レバー	LEVER	1				
056400	アリ	DOVETAIL	1				
056500	ナカワク	INNER FRAME	1				
056600	オサエイタ	SETTING PLATE	1				
056700	メモリカン	SCALE RING	1				
056800	オサエイタ	SETTING PLATE	1				
056900	ワク	FRAME	1				
089600	ゴムカン	KNURLED RING	1				
456700	W-B10	SPACER	0				
456800	W-B20	SPACER	~				
LA418500	レンズ	LENS	1				
LP063800	ケンコウシ	ANALYZER	1				
ZA078600	ハネ	DIAPHRAGM BLADE	8				
ZJ540700	レンズ	LENS W/FRAME	1				
803500	ボールウケ	SPRING W/BALL	1				

A | **B** | **C** | **D**

1

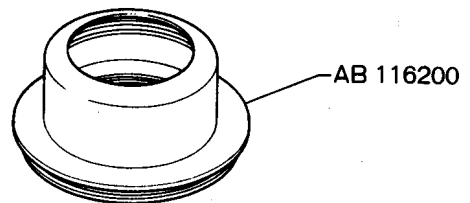

AB 116200

2



LA 468900



AA 204100



LA 468800



AA 670100



AB 093200

3

AA 906600

PUK 2X4SA

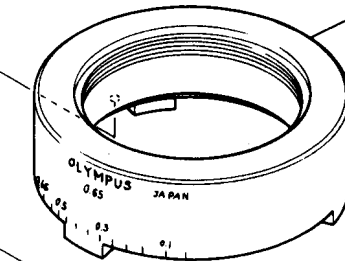

ZA 079400

AB 093500

AB 093600

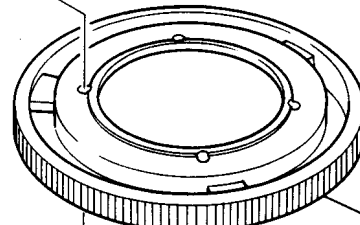

AB 093300

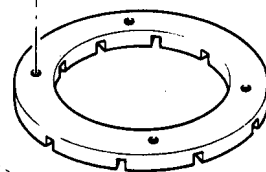

AB 093400

PUK 2X6SA

4

LA 468700

LA 468600

AB 093700

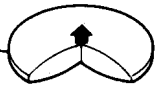
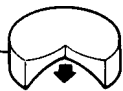

EXPLODED PARTS DIAGRAM

MODEL	UNIT	FIG
BH2	B2-LWCD	37
OLYMPUS OPTICAL CO., LTD. TOKYO, JAPAN		

NOTE: WHEN ORDERING FOR SPARE PARTS, PLEASE CLARIFY A MODEL OR UNIT, PARTS NUMBER AND QUANTITY.

PARTS NO.	NAME OF PARTS		Q' ty	PARTS NO.	NAME OF PARTS		Q' ty
AA204100	リング	RING	1	WE115290	PUK2X4SA	SCREW	4
670100	R	RING	1	115308	PUK2X6SA	SCREW	3
906600	HK	SCREW	1				
AB093200	ホンタイ	BODY	1				
093300	シボリング	DIAPHRAGM RING	1				
093400	ナカザ	INNER FRAME	1				
093500	アリ	DOVETAIL	1				
093600	シタワク	LOWER FRAME	1				
093700	リング	RING	1				
116200	ワク	FRAME	1				
LA468600	レンズ	LENS	1				
468700	レンズ	LENS	1				
468800	レンズ	LENS	1				
468900	レンズ	LENS	1				
ZA079400	ハネ	DIAPHRAGM BLADE	10				

A

B

C

D

1

B2-DCD

AB 055300

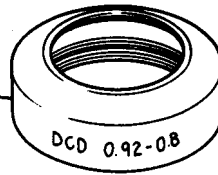

LA 429900

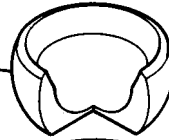

AB 055100

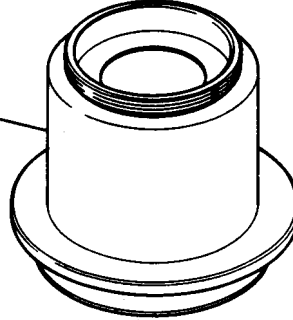

2

3

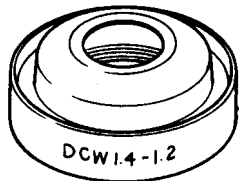

AB 055200

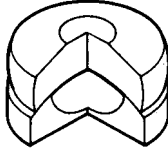

ZJ 543800



AA 948800
AA 948900
AA 949000
AA 949100

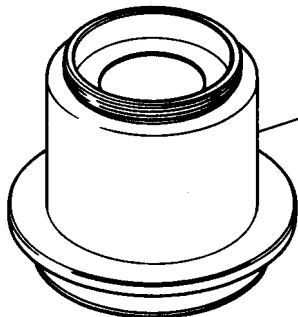

AB 055100

B2-DCW

4

EXPLODED PARTS DIAGRAM

MODEL	UNIT	FIG
BH2	B2-DCD B2-DCW	42

OLYMPUS OPTICAL CO., LTD. TOKYO, JAPAN

NOTE: WHEN ORDERING FOR SPARE PARTS, PLEASE CLARIFY A MODEL OR UNIT, PARTS NUMBER AND QUANTITY.

PARTS NO.	NAME OF PARTS		Q' ty	PARTS NO.	NAME OF PARTS		Q' ty
<u>B 2 - D C D</u>				<u>B 2 - D C W</u>			
AB055100	シタワク	LOWER FRAME	1	AA948800	W	WASHER] 0 ~
055300	ウワワク	TOP LENS FRAME	1	948900	W	WASHER	
				949000	W	WASHER	
LA429900	レンズ	LENS	1	949100	W	WASHER	
				AB055100	シタワク	LOWER FRAME	1
				055200	ウワワク	TOP LENS FRAME	1
				ZJ543800	レンズ	LENS	1

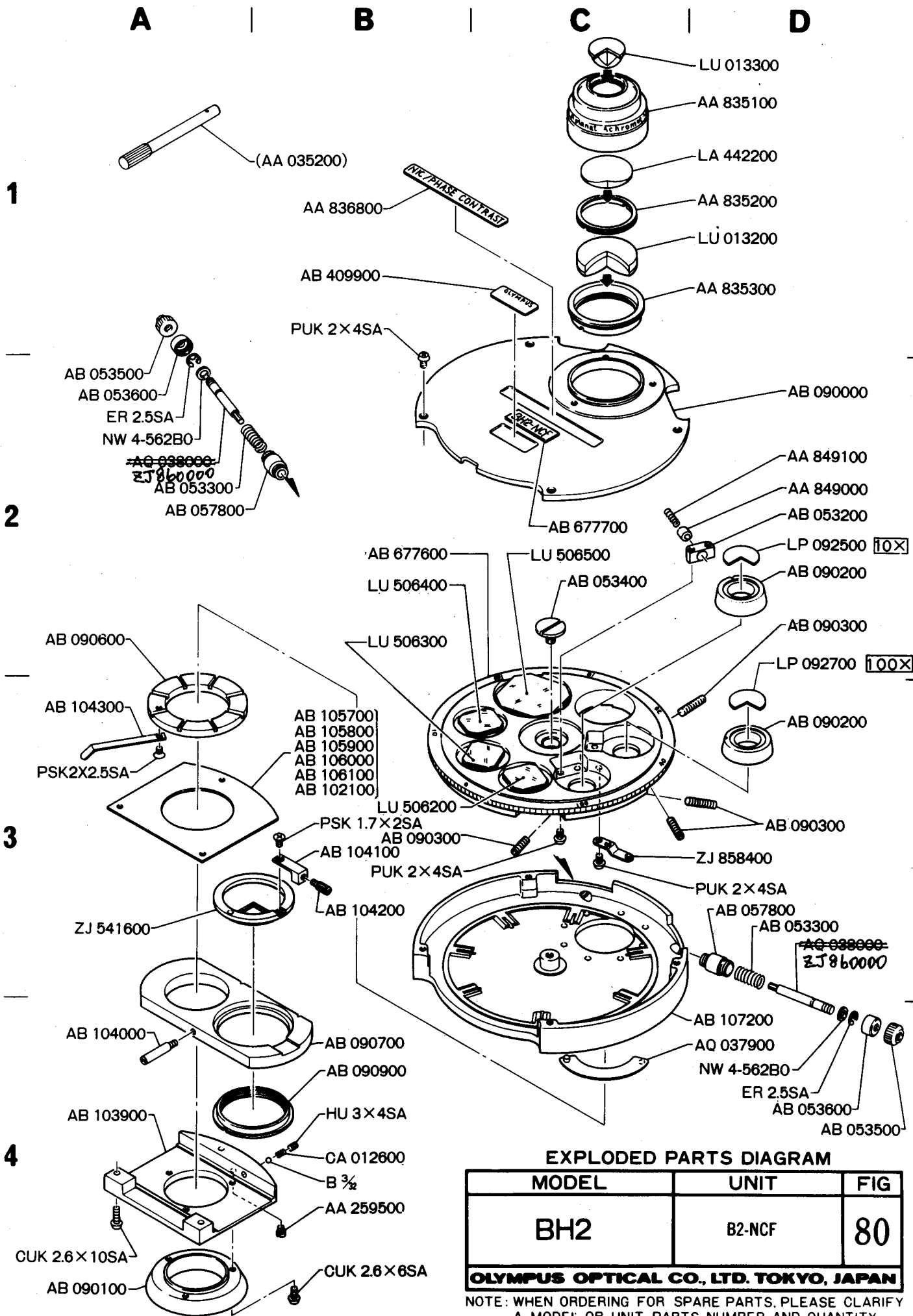

PARTS NO.	NAME OF PARTS	Q' ty	PARTS NO.	NAME OF PARTS	Q' ty
AA259500	HK SCREW	1	ZJ541600	ポラライザ POLARIZER	1
835100	ソトワク OUTER FRAME	1	858400	クリックバネ CLICK SPRING	1
835200	R RING	1	860000	ツマミ KNOB	2
835300	オサエリング RING	1	WE114026	CUK2.6X6SA SCREW	3
836800	メイハン NAME PLATE	1	114002	CUK2.6X10SA SCREW	3
849000	バネトウ SPRING TUBE	2	WE117130	HU3X4SA SCREW	1
849100	バネ SPRING	2	WE107078	PSK1.7X2SA SCREW	1
AB053200	ザ MOUNT	2	107115	PSK2X2.5SA SCREW	1
053300	バネ SPRING	2	WE115290	PUK2X4SA SCREW	10
053400	HK SCREW	1	WE301332	NW4-562B0 WASHER	2
053500	ツマミ KNOB	2	WE307024	ER2.5SA E-RING	2
053600	フタ COVER	2	WE201038	B3/32 BALL	1
057800	ツツ TUBE	2			
090000	NCフタ NC-COVER	1			
090100	NCアリ NC-DOVETAIL	1			
090200	RSワク RS-FRAME	2			
090300	ネジ SCREW	4			
090600	マワシカン ROTATING RING	1			
090700	スライダ SLIDER	1			
090900	シメカン FIXING RING	1			
102100	W-3 WASHER 3	0 ~			
105700	W-5 WASHER 5				
105800	W-10 WASHER 10				
105900	W-20 WASHER 20				
106000	W-30 WASHER 30				
106100	W-40 WASHER 40				
103900	スライダザ SLIDER MOUNT	1			
104000	ツマミ KNOB	1			
104100	ザ MOUNT	1			
104200	ツマミ KNOB	1			
104300	ハンドル LEVER	1			
107200	NCホンタイ NC-BODY	1			
409900	メイハン NAME PLATE	1			
677600	NCターレット NC-TURRET	1			
677700	メイハン NAME PLATE	1			
AQ037900	ハネブクミ A DIAPHRAGM BLADE	8			
038000	レンズタミ KNOB	2			
CA012600	バネ SPRING	1			
LA442200	レンズ LENS	1			
LP092500	リングスリット LIGHT ANNULUS	1			
092700	リングスリット LIGHT ANNULUS	1			
LU013200	レンズタミ LENS ASS'Y	1			
013300	レンズタミ LENS ASS'Y	1			
506200	プリズムタミ PRISM ASS'Y	1			
506300	プリズムタミ PRISM ASS'Y	1			
506400	プリズムタミ PRISM ASS'Y	1			
506500	プリズムタミ PRISM ASS'Y	1			

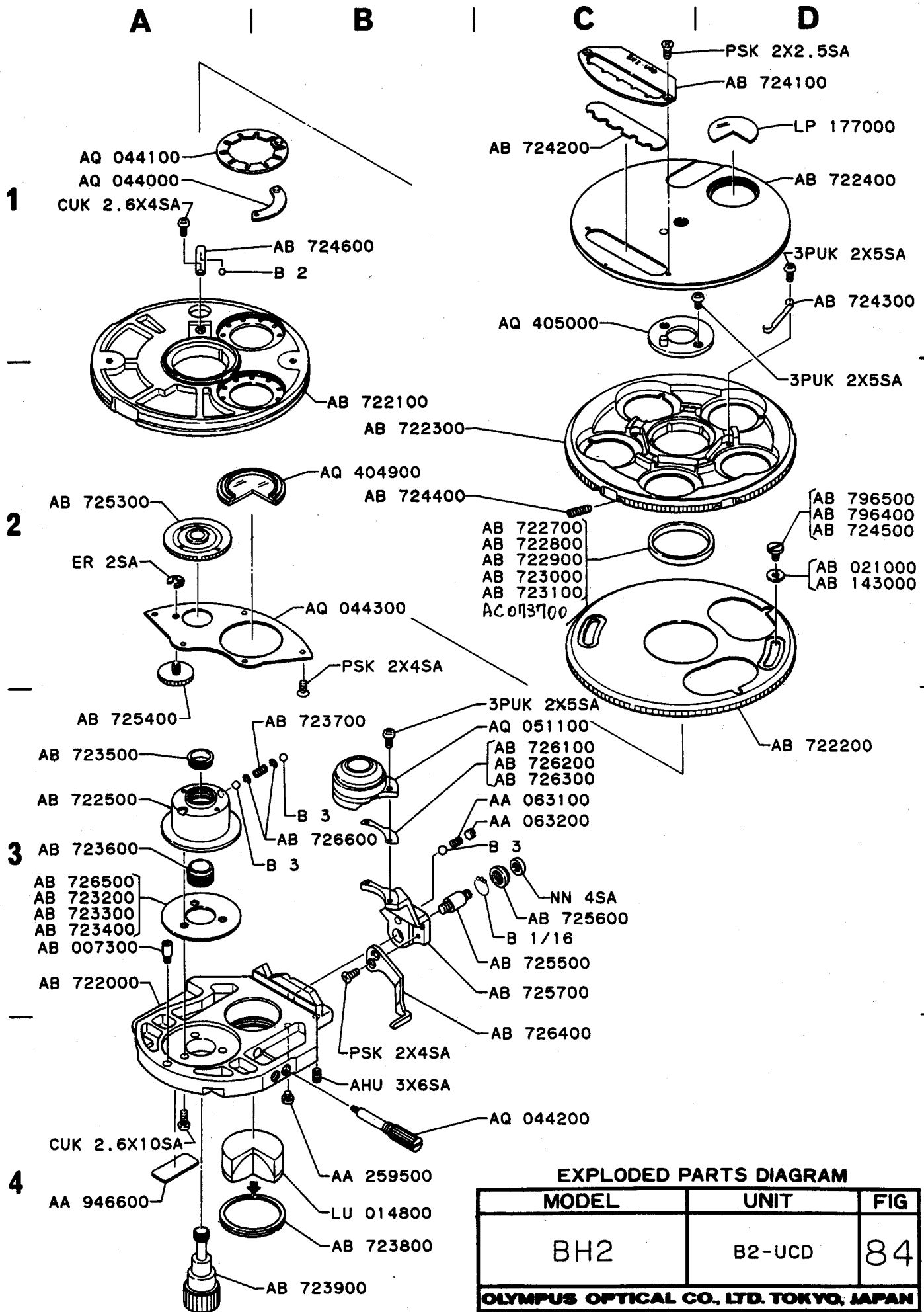

EXPLODED PARTS DIAGRAM

MODEL	UNIT	FIG
BH2	B2-UCD	84

OLYMPUS OPTICAL CO., LTD. TOKYO, JAPAN

NOTE: WHEN ORDERING FOR SPARE PARTS, PLEASE CLARIFY A MODEL OR UNIT, PARTS NUMBER AND QUANTITY.

AR1410

PARTS NO.	NAME OF PARTS	Q' ty	PARTS NO.	NAME OF PARTS	Q' ty		
AA063100	スプリング	SPRING	1	LP009900	ヘンコウシ	FILTER	1
063200	ネジ	SCREW	1	177000	ボウジンガラス	GLASS	1
143000	W	WASHER	0				
AB021000	W	WASHER	~	LU014800	レンズ	LENS	1
AA259500	HK	SCREW	1				
804300	W3	SPACER	1	WE120023	ACU3X6SA	SCREW	2
946600	メイバン	NAME PLATE	1				
				WE114016	CUK2. 6X4SA	SCREW	1
AB007300	HK	SCREW	1	114002	CUK2. 6X10SA	SCREW	3
722000	ベース	BASE	1				
722100	L ターレット	LOWER TURRET	1	WE107115	PSK2X2. 5SA	SCREW	2
722200	ASリング	INNER COVER	1	107143	PSK2X4SA	SCREW	7
722300	U ターレット	U-TURRET	1				
722400	フタ	COVER	1	WE116100	3PUK2X5SA	SCREW	14
722500	ジク1	SHAFT	1				
722700	スペーサ1	SPACER (t=2. 99)		WE503024	NN4SA	NUT	1
722800	スペーサ2	SPACER (t=3. 01)					
722900	スペーサ3	SPACER (t=3. 03)	1	WE307044	ER2SA	E-RING	1
723000	スペーサ4	SPACER (t=3. 05)					
723100	スペーサ5	SPACER (t=3. 07)		WE201036	B1/16	BALL	14
AC073700	スペーサ6	SPACER (t=2. 97)		201024	B2	BALL	1
AB723200	W1-2	SPACER (t=0. 1)		201035	B3	BALL	5
723300	W1-3	SPACER (t=0. 3)	0				
723400	W1-4	SPACER (t=0. 6)	~				
726500	W1-1	SPACER (t=0. 05)					
723500	ナット S	NUT S	1				
723600	ナット L	NUT L	1				
723700	スプリング	SPRING	2				
723800	オサエカン	RING	1				
723900	コテイネジ	SCREW	1				
724100	ヒョウジバン	DISPLAY	1				
724200	マグネシート	MAGNET	1				
724300	UTバネ	SPRING	5				
724400	ネジ	SCREW	10				
724500	ストップバ	STOPPER (φ 4)					
796400	ストップバ2	STOPPER (φ 3. 8)	2				
796500	ストップバ3	STOPPER (φ 3. 6)					
724600	POバネ	SPRING	1				
725400	ロックネジ	SCREW	1				
725500	ジクA	SCREW	1				
725600	ナット A	NUT A	1				
725700	アーム	ARM	1				
726100	W2-1	SPACER (t=0. 3)	0				
726200	W2-2	SPACER (t=0. 1)	~				
726300	W2-3	SPACER (t=0. 05)					
726400	レバー	LEVER	1				
726600	C リング	C-RING	2				
AQ044000	ハネクミ	DIAPHRAGM BLADE	20				
044100	ヤグルマクミ	DIAPHRAGM RING	2				
044200	ドライバクミ	DRIVER	2				
044300	ウラバタクミ	COVER	1				
051100	サキダマクミ	LENS ASS' Y	1				
404900	POクミ	POLARIZING PLATE	1				
405000	リングクミ	RING	1				

A | B | C | D

1

2

3

4

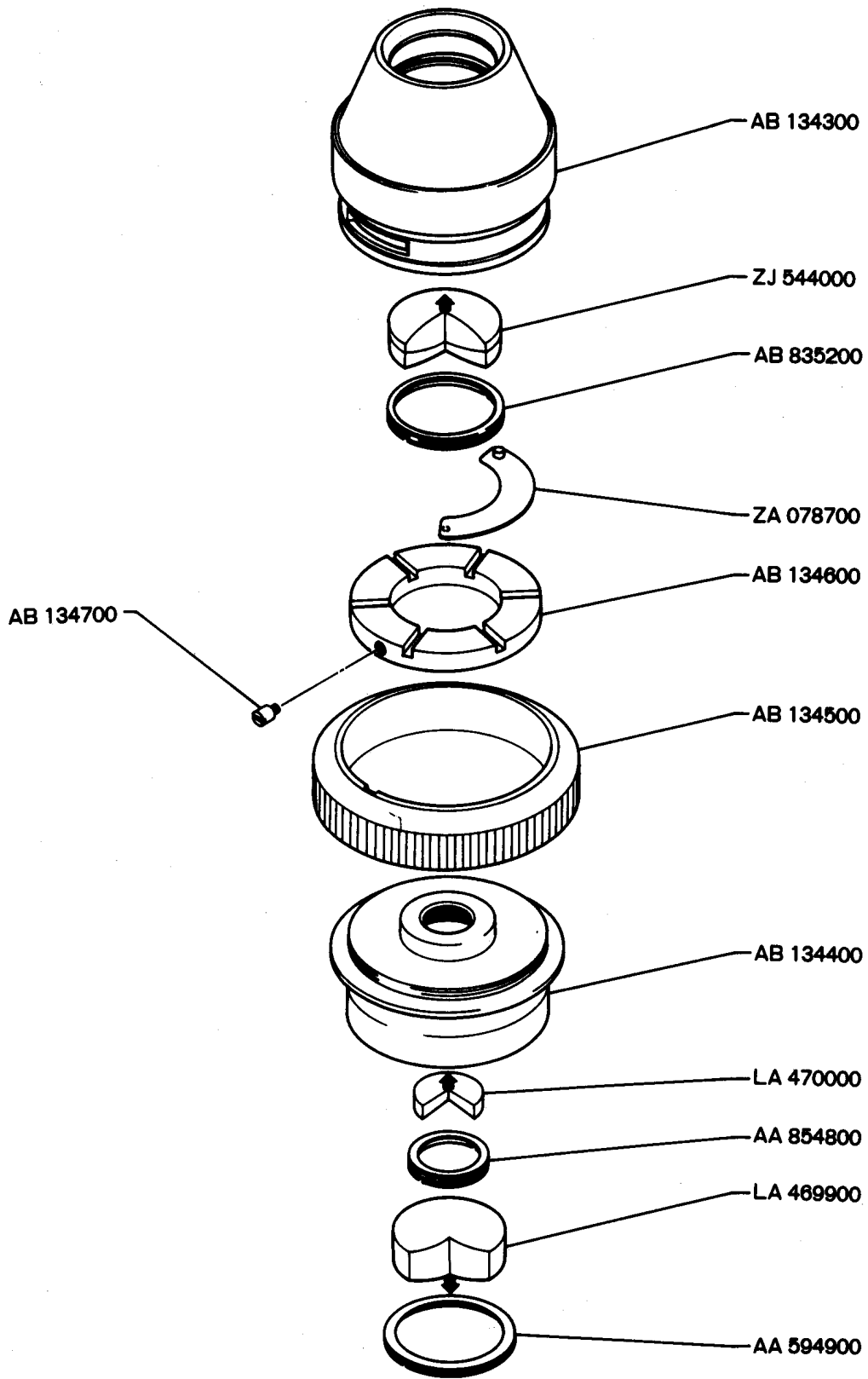

EXPLODED PARTS DIAGRAM

MODEL	UNIT	FIG
BH2	B2-ULC	43

OLYMPUS OPTICAL CO., LTD. TOKYO, JAPAN

NOTE: WHEN ORDERING FOR SPARE PARTS, PLEASE CLARIFY A MODEL OR UNIT, PARTS NUMBER AND QUANTITY.

PARTS NO.		NAME OF PARTS	Q' ty	PARTS NO.	NAME OF PARTS	Q' ty
AA594900	R	RING	1			
835200	R	RING	1			
854800	R	RING	1			
AB134300	ウワク	TOP LENS FRAME	1			
134400	シタク	LOWER FRAME	1			
134500	マワシカン	KNURLED RING	1			
134600	シボリカン	DIAPHRAGM RING	1			
134700	HK	SCREW	1			
LA469900	レンズ	LENS	1			
470000	レンズ	LENS	1			
ZA078700	ハネ	DIAPHRAGM BLADE	6			
ZJ544000	レンズ	LENS	1			